



Professional Radio

GP340

User Guide

68P64110B23A

Issue: July 1999

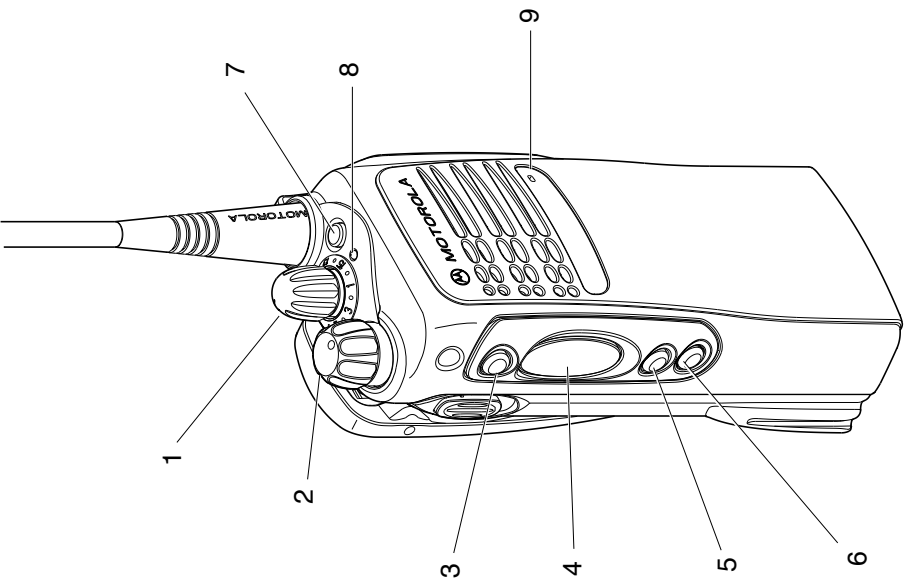
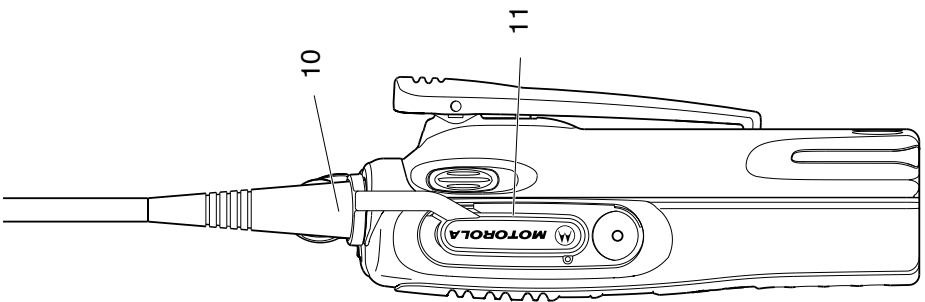

CONTENTS

Radio Overview	3	Selecting a Radio Channel	12
Operation and Control Functions	3	Sending a Call	12
Radio Controls	3	Receiving a Call	12
Programmable Buttons	3	Radio Calls	13
Audio Signal Tones	6	Selective Call	13
Getting Started	7	Making a Selective Call	13
Battery Information	7	Receiving a Selective Call	13
Battery Care and Tips	7	Emergency Call	14
Recycling or Disposal of Batteries	8	Lone Worker	15
Charging the Battery	8	Talkaround	16
Accessory Information	9	Features	17
Attaching the Battery	9	Transmit Power	18
Removing the Battery	9	Whisper	19
Attaching the Antenna	10	Call Forward	20
Removing the Antenna	10	Voice Operated Transmit (VOX)	21
Attaching the Belt Clip	11	Voice Recorder	22
Removing the Belt Clip	11	Scan	23
Radio Operation	12	Starting or Stopping Scan	23
Turning the Radio On-Off	12	Talkback	23
Adjusting the Radio's Volume	12	Deleting a Nuisance Channel	24
		Adding a Deleted Nuisance Channel	24

Safety Information	25
Safe and Efficient Operation	25
Exposure to Radio Frequency Energy	25
Radio Operation and EME Exposure	26
Electromagnetic Interference/ Compatibility	26
Operational Warnings	26
Vehicles with an Air Bag	26
Potentially Explosive Atmospheres	26
Batteries	26
Blasting Caps and Areas	27
Operational Cautions	27
Damaged Antennas	27
Batteries	27
General Radio Care	27

Computer Software Copyright

The products described in this manual may include copyrighted computer programmes stored in semiconductor memories or other media. Laws in the United States of America and other countries preserve for Motorola Europe and Motorola Inc. certain exclusive rights for copyrighted computer programmes, including the right to copy or reproduce in any form the copyrighted computer programme. Accordingly, any copyrighted computer programmes contained in the products described in this manual may not be copied or reproduced in any manner without the express written permission of the holders of the rights. Furthermore, the purchase of these products shall not be deemed to grant either directly or by implication, estoppel, or otherwise, any licence under the copyrights, patents, or patent applications of the holders of the rights, except for the normal non-exclusive royalty free licence to use that arises by operation of the law in the sale of the product.

RADIO OVERVIEW

This user guide covers the operation of the GP340 Portable Radio.

Please read pages 25 to 27 **before** using this radio

OPERATION AND CONTROL FUNCTIONS

Radio Controls

The numbers below refer to the illustrations on the inside front cover.

- 1. Channel Selector Knob**
Allow selection of up to 16 channels.
- 2. On-Off / Volume Knob**
Used to turn the radio on or off, and to adjust the radio's volume.
- 3. Side Button 1 (programmable)**
- 4. Push to Talk Button (PTT)**
Press and hold down this button to talk, release it to listen.
- 5. Side Button 2 (programmable)**
- 6. Side Button 3 (programmable)**
- 7. Top Button (programmable)**
Recommended for Emergency Button.

- 8. LED Indicator**
Green: Successful power up.
Green Flashing: Radio scanning.
Red: Radio transmitting.
Red Flashing: Channel busy - when receiving.
Yellow: Radio called.
Yellow Flashing: Radio call reminder alert.
Red Flashing: Low battery warning - when transmitting.
- 9. Microphone**
Speak clearly into the microphone when sending a message.
- 10. Antenna**
- 11. Accessory Connector**
Connects headsets, remote speaker/microphones and other accessories. Replace attached dust cap when not in use.

Programmable Buttons

























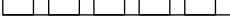

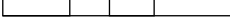

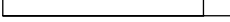
Several of your radio buttons can be programmed, by the Customer Programming Software (CPS), to activate the radio features. The following table shows the features that can be assigned to the Top button and the three Side Buttons.

Feature	Description
Monitor/Cancel	To monitor the selected channel for any activity or to cancel a current outgoing or incoming call.
Radio Call	To make an individual or group selective call.
Scan On/Off	To toggle between start and stop of the scan operation.
Nuisance Delete/ Cancel	To delete a nuisance channel while scanning or delete the message currently being played back from voice storage.
Transmit Power	To toggle your radio's transmit power level between High and Low power.
Talkaround On/Off	To talk directly with another radio without going through a system or dispatcher.
Emergency	To activate the Emergency alarm call.
Lone Worker	To identify yourself as a lone worker. Radio enters emergency sequence unless you respond when prompted by pressing any radio button.
Call Forward	To transfer calls automatically to another radio if you are unable to take the call.

Feature	Description
Whisper	To increase the microphone gain to allow you to speak quietly.
Record/Play-back	To record/play-back incoming calls or memo using voice recorder feature.
Cancel Message	Deletes the message currently being played back from voice recorder (Voice storage).

Audio Signal Tones

High pitched tone Low pitched tone

	Power Up - Radio self-test OK		Priority Call detected
	Power Up - Radio self-test Fail		H/W error - tone continues until valid operation.
	Button Error		Lone Worker Reminder
	Force Monitor (PTT pressed)		Low Battery
	Feature Enable Side Buttons/ Top Button		Cancel Message
	Feature Disable Side Buttons/ Top Button		Incoming Ringing Tone
	Channel Busy Tone/ Engaged		Outgoing Ringing Tone
	Individual Call Alert		Voice Storage Record
	Call Reminder		Voice Storage Warning
	Group Call Alert		Voice Storage Full
	TOT Pre Alert		Channel Free Beep
	Monitor Alert		Incoming Emergency Alert
	Call Failed		
	Scan Start		
	Scan Stop		
	Priority Channel		

GETTING STARTED

BATTERY INFORMATION

Battery Care and Tips

This product is powered by a nickel-cadmium (Ni-Cd), nickel-metal-hydride (NiMH), or lithium-ion rechargeable battery.

The following battery tips will help you obtain the highest performance and longest cycle life from your Motorola rechargeable battery.

- Charge your new battery overnight (**14-16 hrs**) before using it to obtain maximum battery capacity and performance.
 - Charging in non-Motorola equipment may lead to battery damage and void the battery warranty.
 - When charging a battery that is attached to the radio, turn the radio off to ensure a full charge.
 - The battery should be at about 25°C (room temperature) whenever possible. Charging a cold battery (below 10°C) may result in leakage of electrolyte and ultimately, in failure of the battery.
 - Charging a hot battery (above 35°C) results in reduced discharge capacity, affecting the performance of the radio. Motorola rapid-rate battery chargers contain a temperature-sensing circuit to ensure that the battery is charged within these temperature limits.
- New batteries can be stored up to two years without significant cycle loss. Store new/unused batteries, at room temperature, in cool dry area.
 - Batteries which have been in storage should be charged overnight.
 - Do not return fully charged batteries to the charger for an “extra boost”. This action will **significantly** reduce cycle life.
 - Do not leave your radio and battery in the charger when not charging. Continuous charging will shorten battery life. (Do not use your charger as a radio stand.)
 - For optimum battery life and operation use only Motorola brand chargers. They were designed to operate as an integrated energy system.

Recycling or Disposal of Batteries



At the end of its useful life, the NiCd battery can be recycled. However, recycling facilities may not be available in all areas.

Motorola endorses and encourages the recycling of all re-chargeable batteries. Contact your local Motorola dealer for further information.

Charging the Battery

If a battery is new, or its charge level is very low, you will need to charge the battery before you can use it in your radio.

Please contact your dealer for further information.

Note: Batteries are shipped uncharged from the factory. New batteries could prematurely indicate full charge, charge a new battery for 14-16 hrs before initial use.

Charger LED	Status
Red	Battery is charging
Green	Battery is fully charged
Flashing Red *	Battery is unchargeable
Flashing Yellow	Charger is getting ready to charge
Flashing Green	Battery is 90% charged

* Battery is damaged. Please contact your dealer.

1. Place the radio with the battery attached, or the battery alone, in the charger.
2. The charger's LED indicates the charging progress.

Battery chargers will charge only the Motorola authorized batteries listed below; other batteries will not charge.

Part No.	Description
HNN9008	High-Capacity NiMH
HNN9009	Ultra-High-Capacity NiMH
HNN9010	Ultra-High-Capacity FM NiMH
HNN9011	High-Capacity FM NiCd
HNN9012	High-Capacity NiCd
HNN9013	Lithium-Ion

FM - Factory Mutual

ACCESSORY INFORMATION

Attaching the Battery

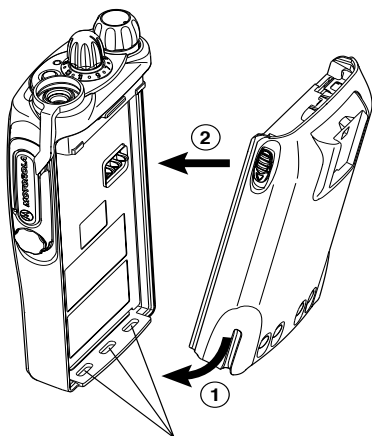

1. Fit the extensions at the bottom of the battery into the slots at the bottom of the radio's body.
2. Press the top part of the battery towards the radio until you hear a click.

Removing the Battery

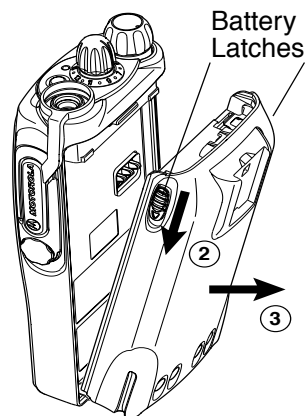

1. Turn off the radio, if it is turned on.
2. Slide the battery latches, on both sides of the battery, downwards.
3. Pull the top part of the battery away from the radio's body, and remove the battery.

Attaching the Antenna

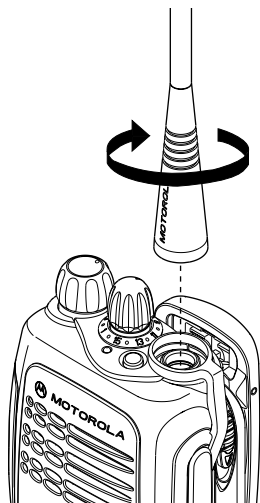

1. Align the threaded end of the antenna with the radio's antenna connector.
2. Turn the antenna clockwise to fasten it.

Removing the Antenna

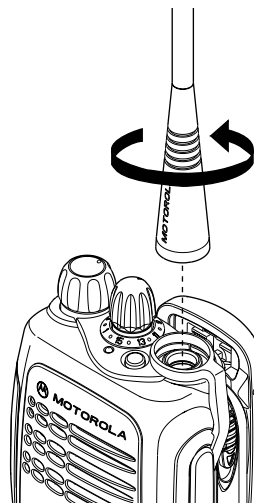

1. Turn the antenna counterclockwise until you can remove it.

Attaching the Belt Clip

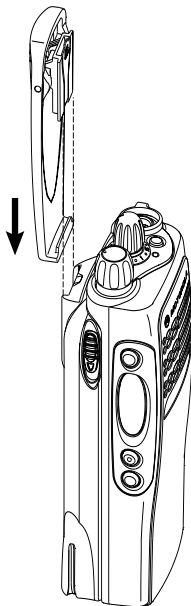

1. Align the grooves of the belt clip with those of the battery.
2. Press the belt clip downwards until a click is heard.

Removing the Belt Clip

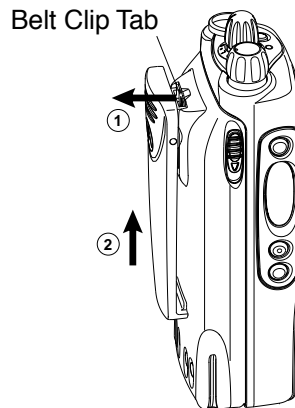

1. Use a key to press the belt clip tab away from the battery.
2. Slide the belt clip upwards to remove it.

TURNING THE RADIO ON OR OFF

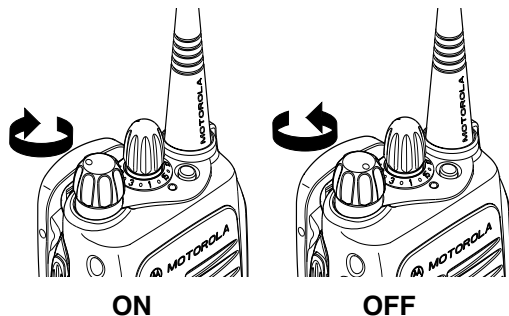

- To turn the radio on, turn the **On-Off/Volume Control** knob clockwise.
- To turn the radio off, turn the **On-Off/Volume Control** knob counterclockwise until you hear a click.

ADJUSTING THE RADIO'S VOLUME

- Turn the **On-Off/Volume Control** knob to adjust the volume level.

SELECTING A RADIO CHANNEL

Your radio offers 16 channels, however some may not be programmed. Check with your dealer for more information.

- Turn the **Channel Selector** knob clockwise or counterclockwise until you reach the desired channel indicated on the selector graduation.

SENDING A CALL

1. Use the **Channel Selector** knob to change to the required channel.
2. Press the **PTT** button and speak clearly into the microphone. Your mouth should be about 2.5 - 5cm away from the microphone.
3. Release the **PTT** button when you finish speaking.

RECEIVING A CALL

1. Turn your radio on and adjust the volume level.
2. Switch to the desired channel.
3. If, at any time, a call is received, you will hear the call at the volume level you have set.

RADIO CALLS

SELECTIVE CALL

Making a Selective Call

You can make a selective call to a particular radio, known as an individual call, or to a selected group of radios, known as a group call.

To make a Selective Call :

1. Press the PTT or Call Button (depending on the way your radio has been programmed by your dealer), to set up the call.
2. Wait until the conversation has been set up, which means you are authorised to use the system.
3. Talk with your mouth 2.5 - 5cm from the microphone. Release PTT to listen.
4. When transmitting the red indicator will light continuously.

Your radio may be configured for 'Transmit Inhibit' under certain conditions (e.g. when the channel is in use by others) in which case, the channel busy tone will sound when you press

the PTT or call button to indicate that transmission is inhibited.

When the channel is free, the Channel Free beep _____will sound, and you can make a call.

If your radio is equipped with a transmit time out timer (TOT), a warning tone _____will sound a few seconds before the transmission is cut off. Your radio may be programmed to inhibit retransmission within a preset time.

Receiving a Selective Call

When you receive a selective call, you will hear either an individual call alert tone , or a group call alert tone _____ and the LED Indicator will light (yellow).

To answer the call:

1. Press the PTT button or Call button.
2. The call will terminate automatically when the conversation has ended or press the Monitor button.

EMERGENCY CALL

Your radio can be programmed to give you a one-button quick access to call a particular radio or centre (predefined by your dealer) in emergency situations. This is the Emergency Call.

When you make an Emergency call, your radio goes into an Emergency state, which can be programmed to:

- continually give audio feedback,
 - give no audio feedback; the radio can receive and transmit.
1. Press the **Emergency** button to initiate an Emergency call.
 2. Emergency can be stopped by:
 - Switching the radio **Off** and **On** again.
 - A **reset** message is received by your radio.
 - The emergency time duration is reached.

Note: The emergency time duration and reset message are programmed into your radio by your dealer.

Should you receive an Emergency call the incoming emergency alert tone will sound.

LONE WORKER

The Lone Worker feature enables you to work alone with added safety. To use this feature :

1. Press the **Lone Worker** button.
2. The feature enable alert _____ will sound.

You will be reminded at intervals that **Lone Worker** is switched **on** by a high pitched alert being sounded .

- Press **any button** to respond and cancel the alert, if you do **not** the radio will enter the Emergency state.

To switch off this feature:

1. Press the **Lone Worker** button when the feature disable alert _____ will sound
or,
2. Change the channel
or,
3. Switch radio **off** and **on** again.

TALKAROUND

In your communications network, you may be using a system to cover a larger area than is possible with your radio. However, you can communicate with another radio within your radio's range without going through the system by using the Talkaround feature. This is especially useful when the system is down. To use this feature:

1. Press the **Talkaround** button to switch **on** talkaround when the feature enable alert _____ will sound.
2. Press the **Talkaround** button again to switch **off** talkaround when the feature disable alert _____ will sound.

FEATURES

The features described below are programmed into your radio by your dealer and are accessible via the radio's programmable buttons.

TRANSMIT POWER

You can transmit your calls at different transmit power levels. A higher level means you can reach a radio that is farther away. A lower power level conserves battery power. You are advised to transmit as frequently as possible on low power, and use high power only when needed. To use this feature :

1. Press the **Tx Power** button to switch to **high power** when the feature enable alert _____ will sound.
2. Press the **Tx Power** button again to switch to **low power** when the feature disable alert _____ will sound.

WHISPER

Whisper allows you to talk quietly into the radio microphone when making a call.

To switch Whisper on:

1. Press the Whisper button once, when the feature enable alert _____ will sound.

To switch Whisper off:

1. Press the Whisper button again, when the feature disable alert _____ will sound.

CALL FORWARD

You can call forward calls to your radio to another radio if you are unable to take calls or are away from your radio.

To enable Call Forward:

1. Press the Call Forward button once, when the feature enable alert _____ will sound.

To disable Call Forward:

1. Press the Call Forward button again, when the feature disable alert _____ will sound.

VOICE OPERATED TRANSMIT (VOX)

When the VOX headset/microphone is connected, your radio may be used with hands-free operation.

To start the VOX feature:

1. Connect the VOX headset onto the accessory connector of the radio.
2. Switch On the radio.

You can disable the VOX feature by pressing the PTT button on the radio. This allows you to use the VOX headset but you must press the radio PTT to transmit.



To re-enable the VOX feature:

1. Switch the OFF and ON again with the headset connected to the accessory connector
or,
2. Change channel with the VOX headset connected.

VOICE RECORDER

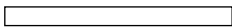

You can record and playback incoming calls or make a memo using the voice recorder feature, which allows up to 2 minutes of recording.

To **record** an incoming call:

1. Press and hold the Record/Playback button, the Voice Storage Recording alert  sounds momentarily.
2. Record the call or part of the call.
3. The Voice Storage Warning alert  sounds when the memory is nearly full.
4. The Voice Storage Full alert  sounds when the memory is full and recording ceases.
5. Release the Record/Playback button at any time to stop recording.

To **record** a memo:

1. Press and hold the Record/Playback button, the Voice Storage Recording alert  sounds momentarily.

2. Speak clearly into the radio microphone to record your memo.
3. The Voice Storage Warning alert  sounds when the memory is nearly full.
4. The Voice Storage Full alert  sounds when the memory is full and recording ceases.
5. Release the Record/Playback button at any time to stop recording.

To **playback** a recorded call or memo:

1. Press the Record/Playback button with the radio in the idle state (i.e. not receiving or transmitting calls) to playback the latest recorded call or memo.
2. Press the Record/Playback button again to skip to the next message to be played back.

To **delete** a recorded call or memo:

1. Press the Cancel Message button to delete the message currently being played back.



SCAN

You can monitor several channels in order to receive any call that is transmitted on any of these channels. Sixteen different channels can be programmed into each scan list. Each channel can share the same scan list or have different scan lists assigned to them.

Once the radio's scan operation is activated and the radio detects a call coming through a channel in its scan list, it switches to that channel for you to receive the call.

STARTING OR STOPPING SCAN

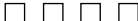
You can start or stop a scan operation by using the **Scan** button.

1. Press the **Scan** button to start scanning. The scan start alert tone  will sound.
2. Press the **Scan** button again to stop scanning. The scan stop alert tone  will sound.

The LED indicator will blink green during a scan operation; it will stop blinking when the radio switches to a channel.

TALKBACK

If the programmable Talkback option is set, you can respond to any calls received during the scan operation by pressing the PTT button before the programmed hang-time ends. Check with your dealer for details.

DELETING A NUISANCE CHANNEL

If a channel continually generates unwanted calls/noise (a “nuisance” channel), you can temporarily remove it from the scan list by performing a Nuisance Channel Delete operation:

1. While the radio is on the Nuisance Channel, press and hold the **Nuisance Delete/Cancel** button until you hear the scan start alert tone _____.
2. Release the **Nuisance Delete/Cancel** button.

Note: You cannot perform a Nuisance Channel Delete on a priority channel or if there is only one remaining channel in the scan list.

ADDING A DELETED NUISANCE CHANNEL BACK INTO THE SCAN LIST

1. Press the **Scan** button to stop scanning. The scan stop alert tone _____ will sound.
2. Press the **Scan** button again to re-start scanning. The scan start alert tone _____ will sound, and the scan list will contain all programmed channels.

SAFETY INFORMATION

Safe and Efficient Operation of Motorola Two-Way Radios

This section provides information and instructions for the safe and efficient operation of Motorola Portable and Mobile Two-Way Radios.

For information regarding radio use in hazardous areas, please refer to the Factory Mutual (FM) approval manual supplement or Instruction Card which is included with radio models that offer this capability.

Exposure To Radio Frequency Energy

National and International Standards and Guidelines

Your Motorola Two-Way Radio, which generates and radiates radio frequency (RF) electromagnetic energy (EME) is designed to comply with the following National and International Standards and Guidelines regarding exposure of human beings to radio frequency electromagnetic energy:

- Federal Communications Commission Report and Order No. FCC 96-326 (August 1996)
- American National Standards Institute (C95.1 - 1992)

- National Council on Radiation Protection and Measurements (NCRP - 1986)
- International Commission on Non-Ionizing Radiation Protection (ICNRP - 1986)
- European Committee for Electrotechnical Standardisation (CENELEC):
 - ENV. 50166-1 1995 E Human Exposure to Electromagnetic Fields Low Frequency (0Hz to 10kHz)
 - ENV. 50166-2 1995 E Human Exposure to Electromagnetic Fields High Frequency (10kHz to 300GHz)
 - Proceedings of SC211/8 1996 Safety Considerations for Human Exposure to E.M.F.s from Mobile Telecommunications Equipment (M.T.E.) in the Frequency Range 30MHz - 6 GHz (E.M.F. - Electromagnetic Fields)

To assure optimal radio performance and that human exposure to radio frequency electromagnetic energy is within the guidelines set forth in the above standards, always adhere to the following procedures:

Portable Radio Operation and EME Exposure



When transmitting with a portable radio, hold the radio in a vertical position with its microphone 2.5 to 5 centimeters (1 to 2 inches) away from your mouth. Keep antenna at least 2.5 centimeters (1 inch) from your head and body.

If you wear a portable two-way radio on your body, ensure that the antenna is at least 2.5 centimeters (1 inch) from your body when transmitting.

Electromagnetic Interference/Compatibility

Note: Nearly every electronic device is susceptible to electromagnetic interference (EMI) if inadequately shielded, designed or otherwise configured for electromagnetic compatibility.

To avoid electromagnetic interference and/or compatibility conflicts, turn off your radio in any facility where posted notices instruct you to do so. Hospitals or health care facilities may be using equipment that is sensitive to external RF energy. When instructed to do so, turn off your radio when on board an aircraft. Any use of a radio must be in accordance with airline regulations or crew instructions.

Operational Warnings



WARNING

Vehicles With an Air Bag

Do not place a portable radio in the area over an air bag or in the air bag deployment area. Air bags inflate with great force. If a portable radio is placed in the air bag deployment area and the air bag inflates, the radio may be propelled with great force and cause serious injury to occupants of the vehicle.

Potentially Explosive Atmospheres

Turn off your two-way radio when you are in any area with a potentially explosive atmosphere, unless it is a radio type especially qualified for use in such areas (for example, Factory Mutual or CENELEC Approved). Sparks in a potentially explosive atmosphere can cause an explosion or fire resulting in bodily injury or even death.

Batteries

Do not replace or recharge batteries in a potentially explosive atmosphere. Contact sparking may occur while installing or removing batteries and cause an explosion.

Blasting Caps and Areas

To avoid possible interference with blasting operations, turn off your radio when you are near electrical blasting caps, in a blasting area, or in areas posted: "Turn off two-way radio." Obey all signs and instructions.

Note:

The areas with potentially explosive atmospheres referred to above include fueling areas such as: below decks on boats; fuel or chemical transfer or storage facilities; areas where the air contains chemicals or particles, such as grain, dust or metal powders; and any other area where you would normally be advised to turn off your vehicle engine. Areas with potentially explosive atmospheres are often but not always posted.

Operational Cautions



Caution

Damaged Antennas

Do not use any portable two-way radio that has a damaged antenna. If a damaged antenna comes into contact with your skin, a minor burn can result.

Batteries

All batteries can cause property damage and/or bodily injury such as burns if a conductive material such as jewellery, keys, or beaded chains touch exposed terminals. The conductive material may complete an electrical circuit (short circuit) and become quite hot. Exercise care in handling any charged battery, particularly when placing it inside a pocket, purse, or other container with metal objects.

General Radio Care



Caution

- The use of chemicals such as detergents, alcohol, aerosol sprays, and/or petroleum products may be harmful to and damage the radio housing.
- Avoid physical abuse of the radio such as carrying it by the antenna.
- The accessory connector (if fitted) has a protective cap which should be left in place when the connector is not in use.
- Clean the radio exterior using a cloth moistened with clean water and a mild dishwashing liquid.
- The use of non-approved radio accessories may damage the radio and invalidate warranty.

NOTES